

Tek-Lens II Model 820S

(Spherical biconvex design)

Blue Light Filter

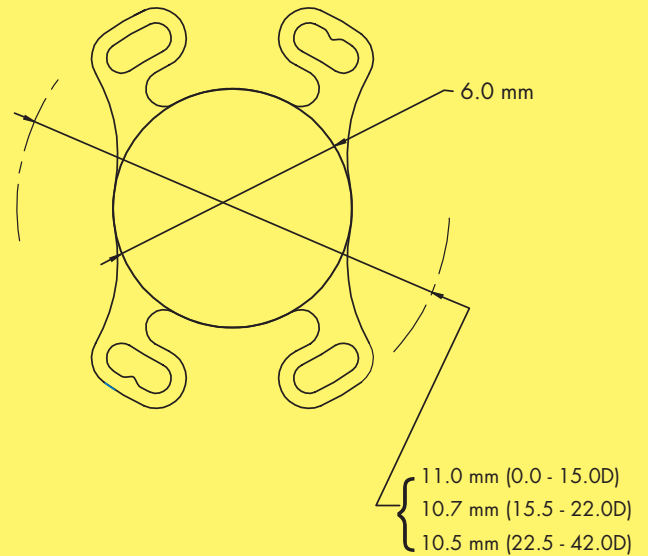
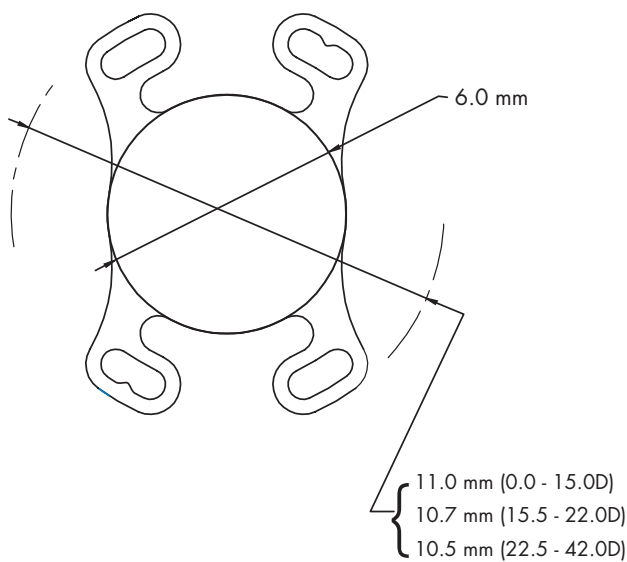

820YS

Indications: Posterior chamber/cataract surgery

Additional Specifications

Not available in the United States

Optical hydrophilic acrylic with UV blocker (26% water content)

Diopter range= 0.0 to 42.0

0.0 to 10.0	x	1.0 increments
10.0 to 30.0	x	0.5 increments
30.0 to 42.0	x	1.0 increments

Refractive Index=1.457 @ 35°C (fully hydrated)

Light transmission > 95%

Spherical biconvex design

Square optic edge

Incision size - 1.8 mm

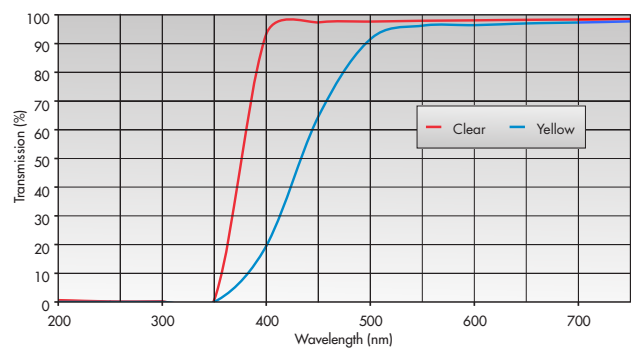

CERTIFIED
ISO 13485



TEKIA