

616Y

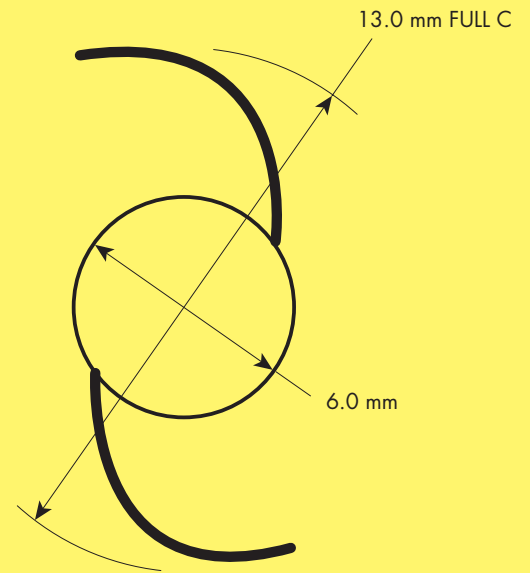
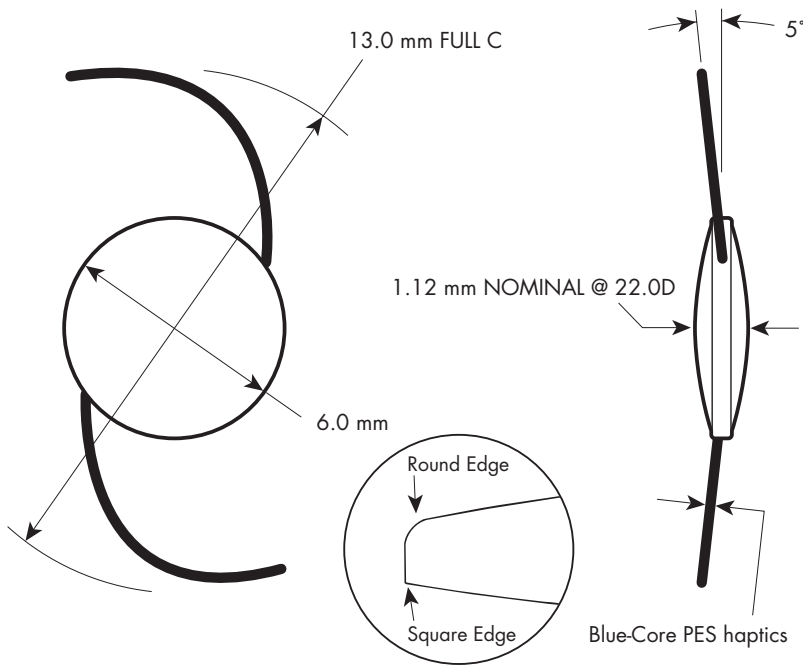

Indications: Posterior chamber/cataract surgery

Additional Specifications

Not available in the United States

Optical hydrophilic acrylic with UV blocker (26% water content)

Diopter range= 0.0 to 35.0

0.0 to 10.0	x	1.0 increments
10.0 to 30.0	x	0.5 increments
31.0 to 35.0	x	1.0 increments

Refractive Index = 1.457 @ 35° C (Fully hydrated)

Light transmission > 95%

Equal biconvex design

Round-square optic edge

Incision size - Sub 2.8 mm

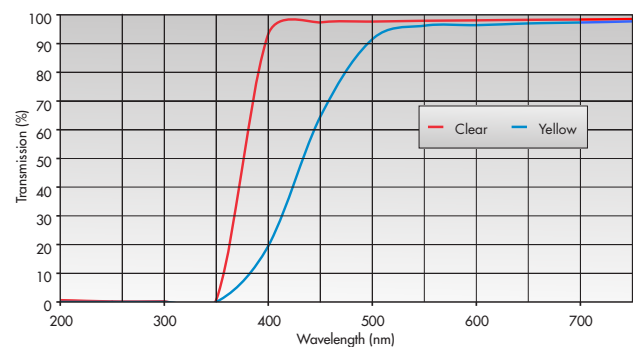

CERTIFIED
ISO 13485



TEKIA